

Ø DN (mm)	L	Ø D	Ø k	Ø d4	b	f	n	Ø d2	H	Ø E	Gewicht (kg)
PN 16											
250	450	405	355	320	26	3	12	26	930	400	200
300	500	460	410	378	28	4	12	26	1085	450	280
400	600	580	525	490	32	4	16	30	1307	550	560
500	700	715	650	610	36	4	20	33	1730	600	1000
600	800	840	770	725	40	5	20	36	2025	650	1369

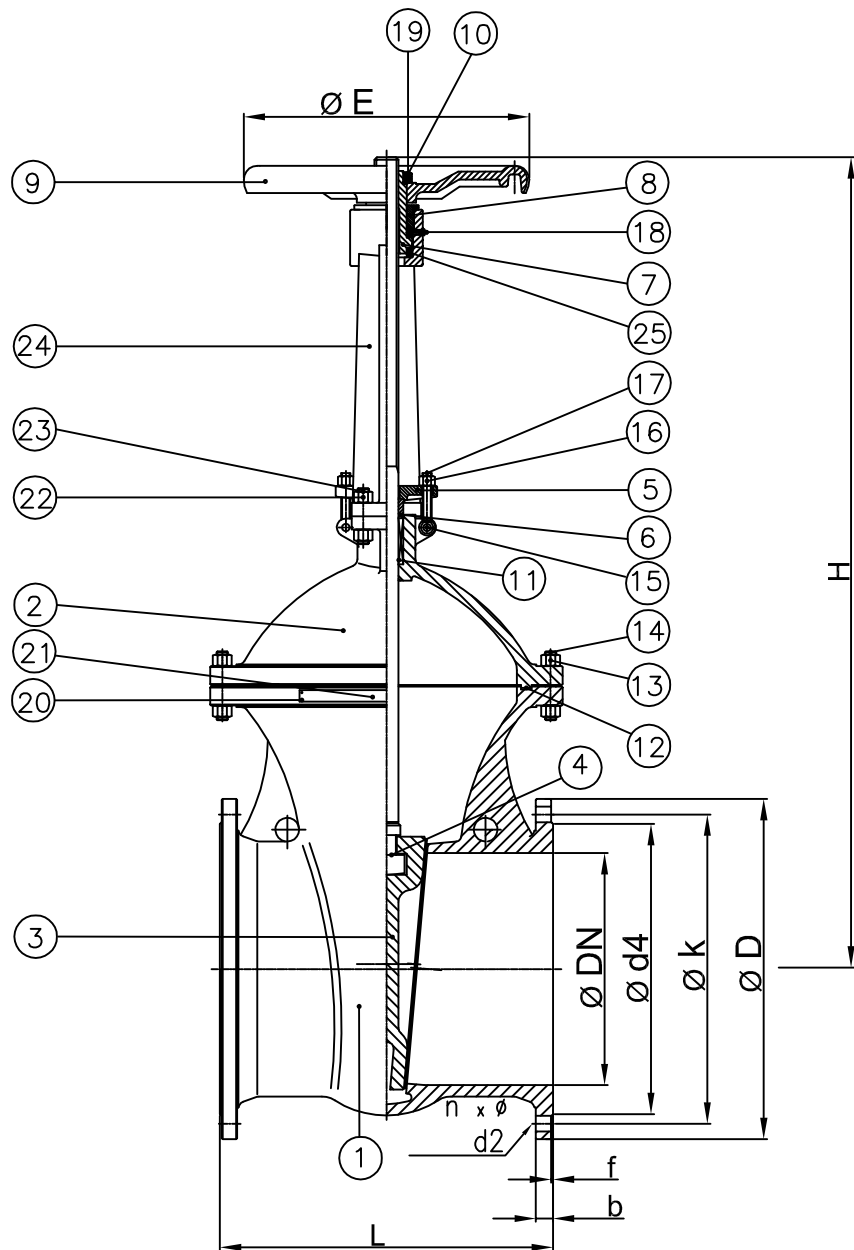

Item	Parts name	Bezeichnung	Material
1	Body	Gehäuse	1.0619+13Cr
2	Bonnet	Deckel	1.0619
3	Wedge	Schieberplatte	1.0619+13Cr
4	Stem	Spindel	X20 Cr13
5	Gland Flange	Stopfbuchsbrille	1.0619
6	Gland	Stopfbuchse	X20 Cr13
7	Stem Nut	Gewindebuchse	0.7660
8	Retaining Nut	Lagermutter	1.1181
9	Handwheel	Handrad	GGG-40
10	Handwheel Nut	Handradmutter	1.1181
11	Stem Packing	Packung	Graphite
12	Bonnet Gasket	Deckel Dichtung	Graphite + 304
13	Body/Bonnet Nuts	Gehäusemutter	A194 2H*
14	Bonnet Bolts	Gewindebolzen	A193 B7*
15	Hinge Pin	Stift	1.1181
16	Gland Nuts	Stopfbuchsmuttern	A194 2H*
17	Eyebolts	Ringschraube	A193 B7*
18	Grease Nipple	Schmiernippel	SS
19	Pin	Gewindestift	CS
20	Grooved Drive Stud	Kerbnagel	SS
21	Nameplate	Typenschild	SS
22	Nut	Mutter	A194 2H*
23	Bolt	Bolzen	A193 B7*
24	Yoke	Bügelaufsatz	1.0619
25	Bearing	Lager	Subassembly

\*Material acc. AD 2000 available  
Schraubenwerkstoff nach AD 2000 möglich

Face-to-face dimensions/Baulänge: DIN EN 558-1 Reihe 15		EN 10204	Designed by: DZ	Checked by: RS	Date: 24/05/17
Type: Absperrschieber Typ TOPAS					
Class/Druckstufe: PN16		Size/Nennweite: DN250 - DN600			
Flanged ends dimensions/Flanschmaße: DIN 2526					Rev: 0

**kihsco**  
Valves Europe GmbH